

REVISIONS			
REV.	DESCRIPTION	DATE	CHANGED BY
1	Initial release	05/01/2024	GYRI

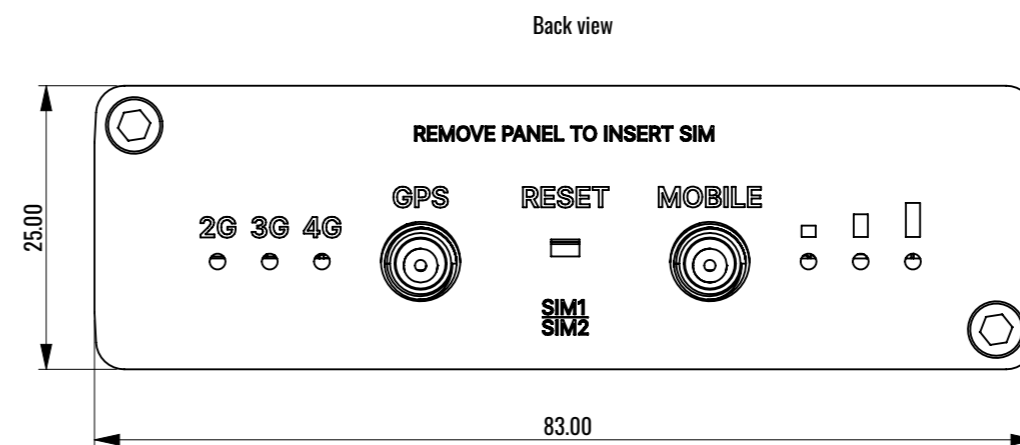

General tolerances					
Part Number:	0503_TB246DAM0BCX_01				
Description:					
Drawn by:	Date:	Material:			
GYRI	05/01/2024				
Approved By:	Date:	Volume:	cm ³	Weight:	g
GYRI	05/01/2024				
	Project:	Units:	mm	Scale:	1.5:1
		Form.:	A3	Sheet:	1/3

Isometric view

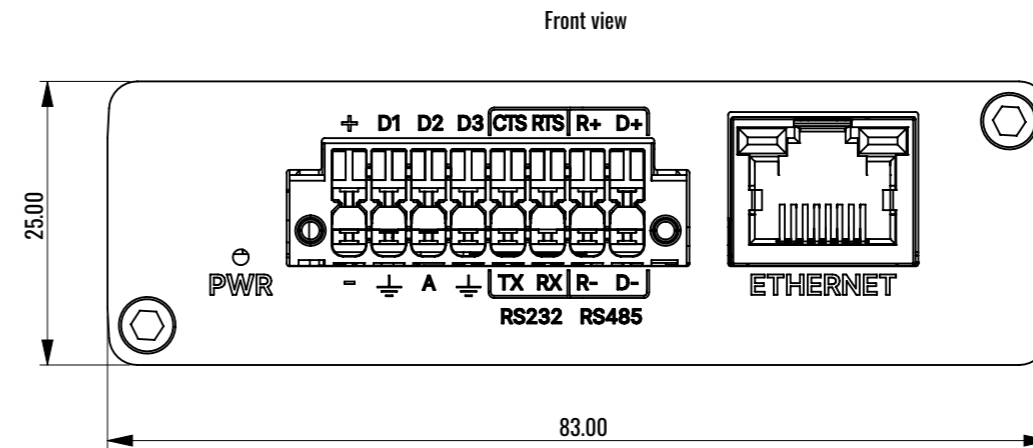
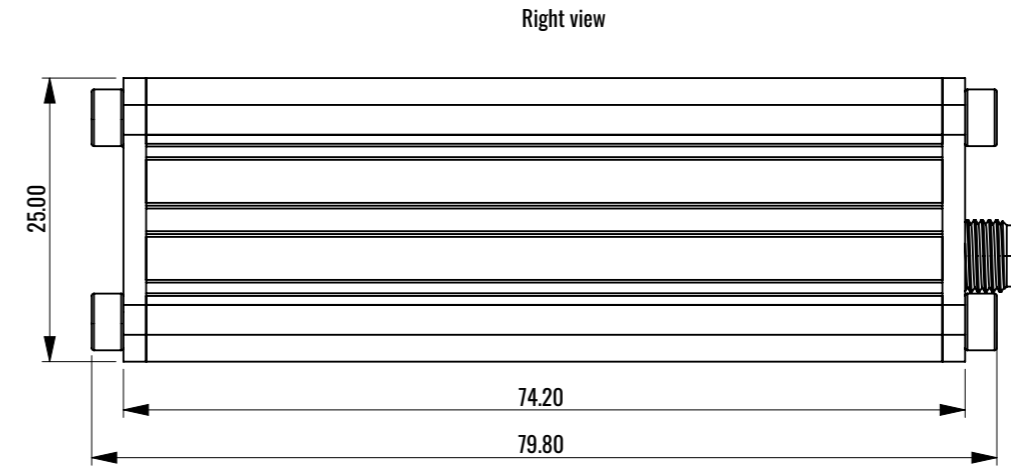
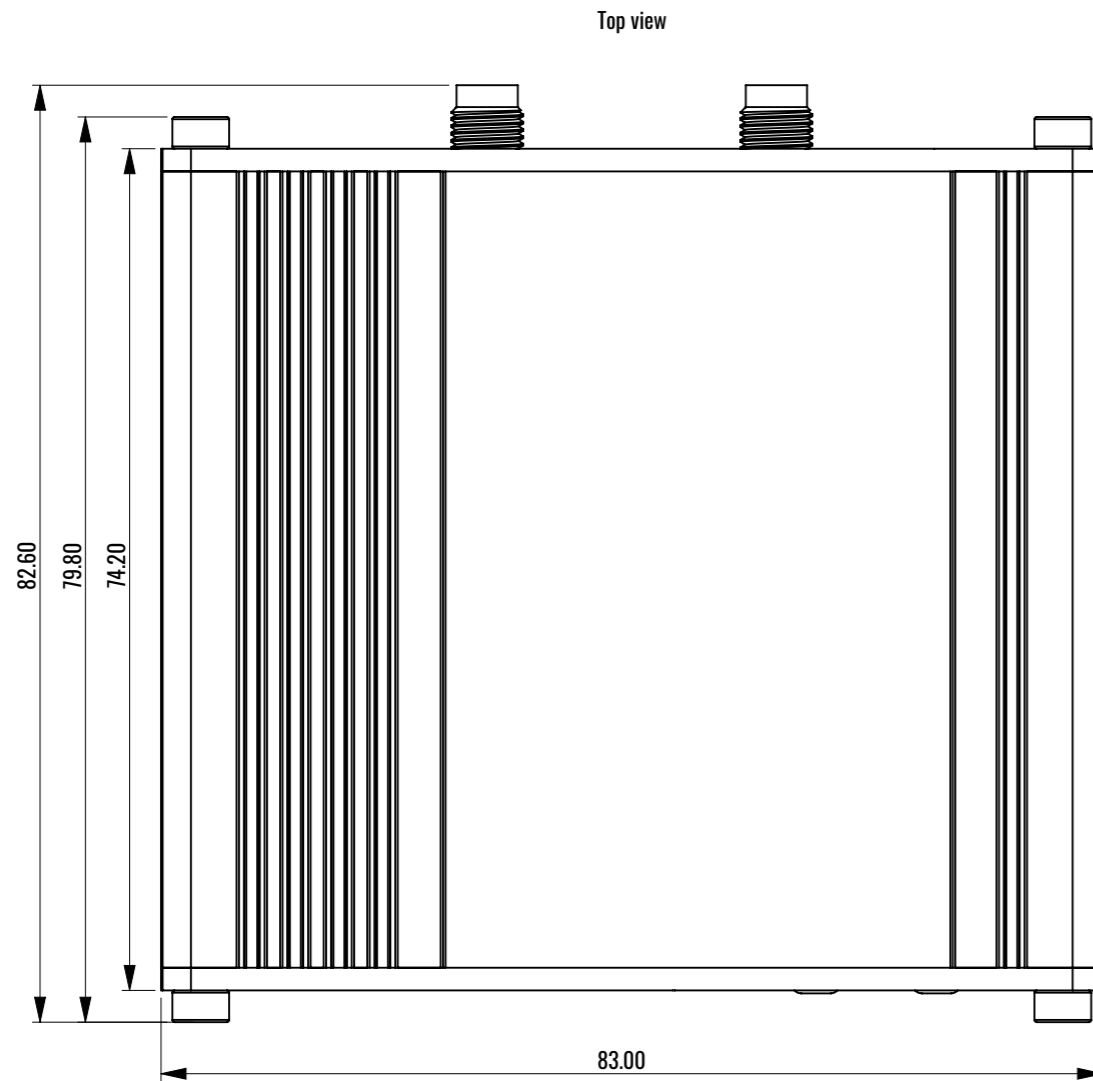
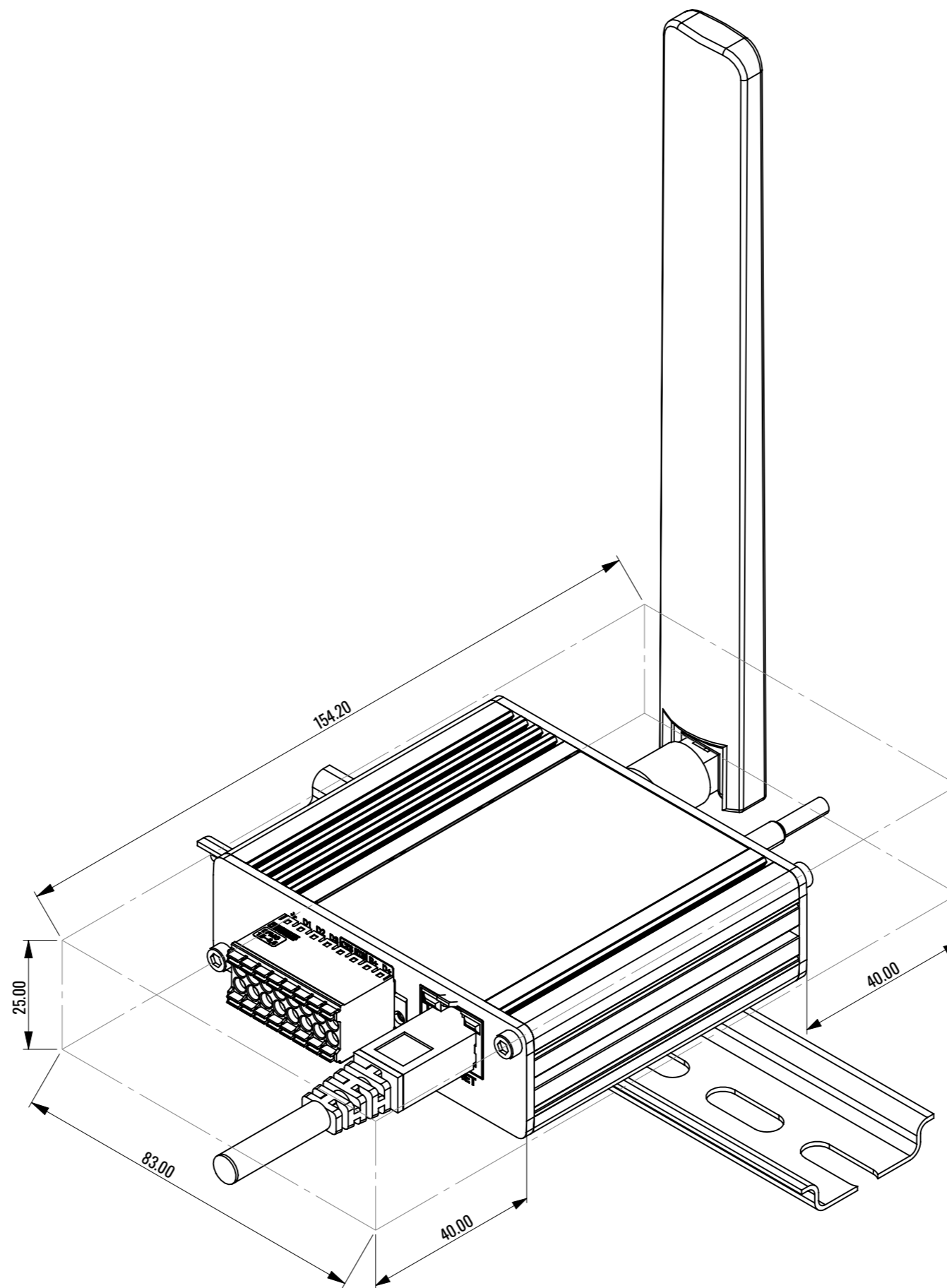

Part Number:	0503_TB246DAM0BCX_01				
Description:					
Units:	mm	Scale:	1:1	Form.:	A3
Sheet:	2/3				

Right view

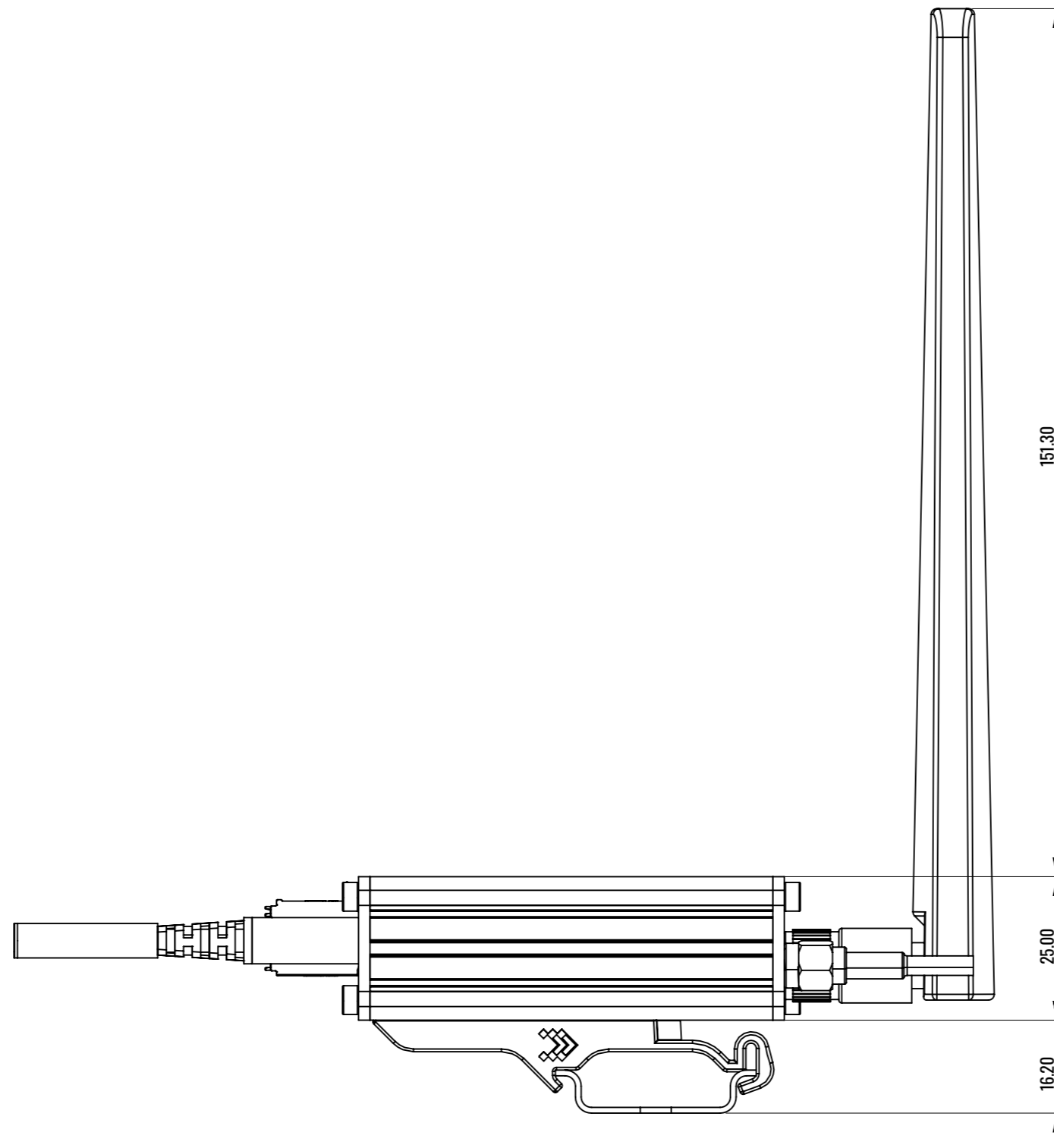

Part Number:	0503_TB246DAM0BCX_01						
Description:							
Units:	mm	Scale:	1:1	Form.:	A3	Sheet:	3/3